

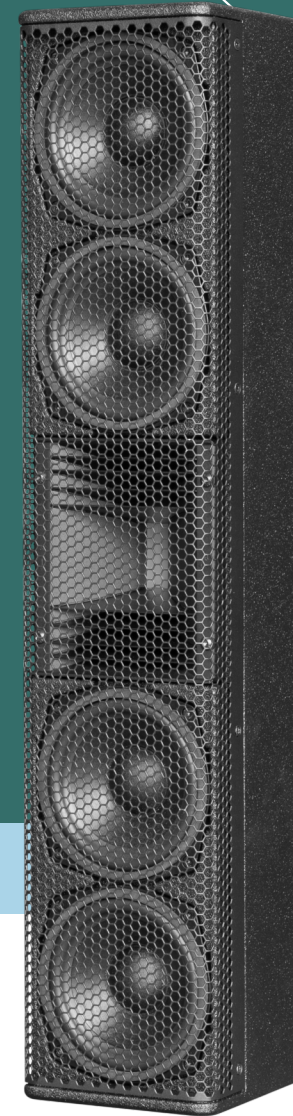

QRP20

point source column

product manual



evolutionary audio solutions™

Table of contents

| | | |
|----|---|----|
| 1 | Introduction | 3 |
| 2 | Product Description | 4 |
| 3 | Precautions | 5 |
| 4 | Connection | 6 |
| 5 | Installation | 9 |
| 6 | Operation | 12 |
| 7 | Accessories & options | 14 |
| 8 | Specifications | 17 |
| 9 | Simulation | 20 |
| 10 | Service and support | 23 |
| 11 | Declaration of conformity | 24 |

1. Introduction

Dear customer,

Congratulations on your purchase of an Alcons Audio QRP20 column array system, and thank you for your confidence in Alcons products.

We are very honoured to welcome you to the growing family of Alcons ambassadors!

The Alcons systems are handmade with pride in The Netherlands, combining the latest production techniques and technologies with dedication and traditional craftsmanship.

Ever since its founding in 2002, the Alcons Audio team has been striving for the best possible sound reproduction for any type of source material and in any size of application. To get the best performance out of your Alcons system, please read the precautions section in this manual before installing and operating.

We wish you many happy listening hours!
With best regards from the Alcons team,

Tom H. Back
Managing Director

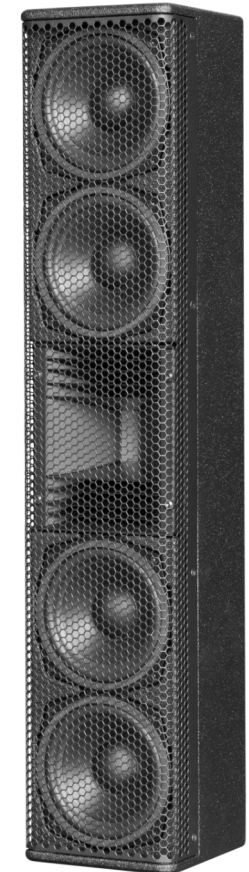

2. Product Description

QRP20 - point source column

- Point source column with high-Q directivity for increased projection control
- RBN401 pro-ribbon HF driver with exceptional intelligibility and “throw”
- 1:1 non-compressed linear sound reproduction, with up to 90% less distortion
- All Neodymium drivers for excellent performance-to-weight ratio
- SIS™ pre-wired for very high damping and further reduced distortion
- Shallow form factor and ACO™ colour option for unobtrusive deployment

The QRP20 is a 2-way column loudspeaker to be used as vertical sound system, for both permanent and portable applications. Its slim design packs a perfectly natural, dynamic sound reproduction with superb intelligibility, coverage and throw.

It is specifically designed for applications where ultimate fidelity response needs to be projected with wide horizontal and narrow vertical coverage, ideal in acoustically challenging environments, or applications where intelligibility-over-distance is required.

Loaded with the RBN401 4” pro-ribbon driver on a “Morpher” lens, the system offers an exceptional, SPL-independent throw-efficiency and projection control, due to the pro-ribbon’s all-natural cylindrical (isophasic) wavefront. The patented (90-degrees) horizontal dispersion offers a wide and consistent audience coverage up to the highest frequencies.

Its fast impulse response, “compression-less” principle and unusual high peak power handling (800W @ 200ms) cater for a perfect intelligibility from the lowest to the highest SPL with a 1:15 dynamic range, while offering a maximum “gain-before-feedback”.

The RBN401 driver is mounted in a D'Appolito speaker configuration with four woofers in a sealed cabinet. The custom-design 5” woofers feature Active Coil™ technology for extremely low-distortion LF reproduction, a perfect match with the MHF pro-ribbon technology. The frequency response roll-off enables an excellent partnering with additional subwoofers.

The system brings the unsurpassed clear, dynamic and ultra-low distortion Alcons signature sound in a very slim and unobtrusive package; The M10 mounting points on top and bottom and the M6 universal mounting bracket pattern on the back, together with the optional ACO™ color scheme provides for an inconspicuous, low-profile presence in any application.

The QRP20 is powered and controlled by the ALC amplified loudspeaker controller; Through the integrated VHIR™ processing, audiophile amplifier stages and Signal Integrity Sensing™ feedback circuit, the ALC offers QRP20-specific drive processing, delivering absolute maximum sound quality with increased headroom and utmost operation reliability and flexibility.

The QRP20 is available in two versions with 90-degree (QRP20/90) and 120-degree (QRP20/120) horizontal dispersion.

3. Precautions

Read this manual carefully before installing and operating your system. Retain this documentation for future reference.

1. Due to the extremely low distortion performance of the Alcons sound systems, the experienced sound pressure level is higher than it appears. Prolonged exposure to high sound pressure levels can lead to hearing damage; Protective gear should always be available.
2. Work with qualified personnel for installing the system; Installation should only be carried out by qualified personnel who are familiar with the techniques, procedures and safety recommendations stated in this manual.
3. Ensure health and safety during installation and operation; All persons must wear protective headgear and footwear at all times.
4. Check conformity of any configuration and respect the maximum allowed values and the safety level recommended by Alcons Audio outlined in this manual.
5. Verify that the Working Load Limit (WLL) of all mounting hardware and accessories is respected. Alcons Audio is not responsible for any equipment and accessories provided by third party manufacturers.
6. Ensure that the surface is suitable for mounting a loudspeaker; Do not mount the loudspeaker assembly on unstable ground or surface. As a general rule, Alcons Audio recommends the use of safety straps at all times.
7. Do not make connections with the loudspeaker to the amplifier while it is switched on. Always shut off the amplifier when making connections to it, and mute the inputs when making connections to preceding equipment in the chain.
8. Do not operate the system in wet environments and protect it from excessive water or sun / UV exposure. The system has an IP43 rating and should be treated accordingly.
9. Regularly check the loudspeaker for damage to the transducers, cabinet and mounting points, as this can severely compromise the system's performance. Refer servicing to qualified service personnel. When in doubt, contact the factory on support@alconsaudio.com.
10. Save the packing material. Should you ever need to ship the loudspeaker, use only the original packing.

4. Connection

The QRP20 is a passive-filtered loudspeaker and features a high quality crossover network. As such, the QRP20 requires one processing/amplifier channel for amplification. To activate the Signal Integrity Sensing™ circuit in the amplified loudspeaker controller (ALC), the use of a 4-core loudspeaker cable with NL4 Speakon® connectors is required;

The two extra wires are used for voltage sensing at the loudspeaker terminals. The output+ and sense+ wires are connected together at the loudspeaker+ terminal, and the output- and sense- wires are connected together at the loudspeaker- terminal.

The Speakon® connector is wired as follows:

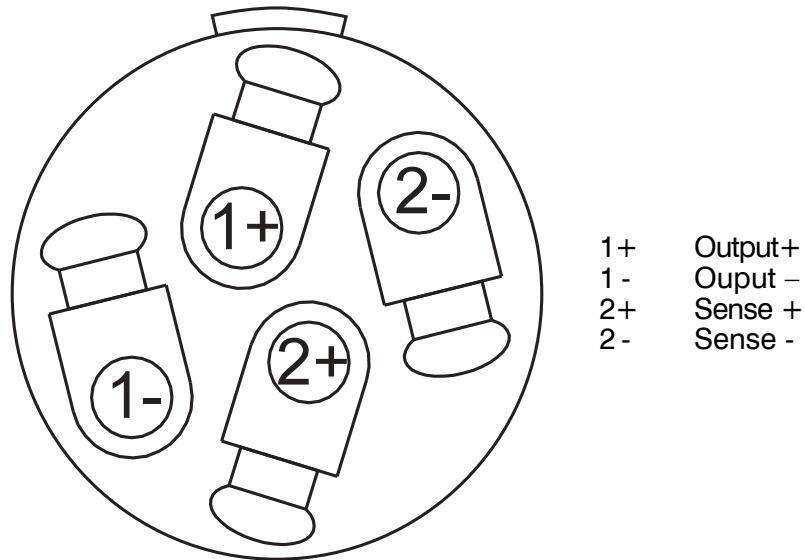

Speakon®male plug viewed from the wiring side

4. Connection

If you do not want to use the SIS feature at all, the sense wires should be connected to the output wires at the amplifier output in the Speakon® connector.

Warning!

Never connect the sense+ to the output- terminal or vice versa, or short circuit both sense wires! Since you are disabling the amplifier's feedback network, the amplifier can produce a large amount of DC at its output. Through its protection circuitry, the Sentinel will shut-off and will not pass any audio.

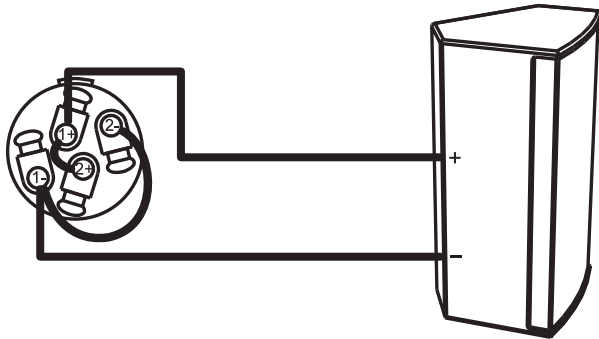

Loudspeaker connection without SIS™

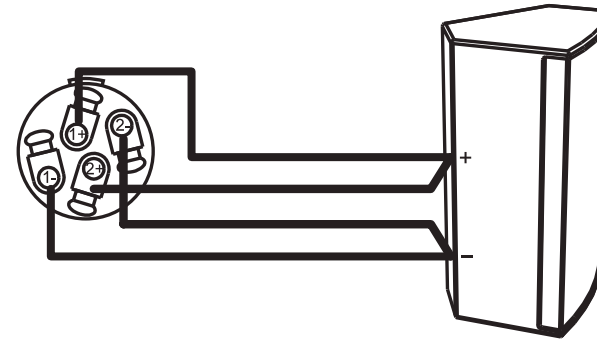

Normal loudspeaker operation

Use bridge mode when you want to combine the power of amplifier channel 1+2 or 3+4 into one loudspeaker load.

In bridge mode connect your loudspeaker with or without SIS to the channel 1 and channel 2 outputs (or channel 3 and 4) as shown above. Sentinel 3 only!

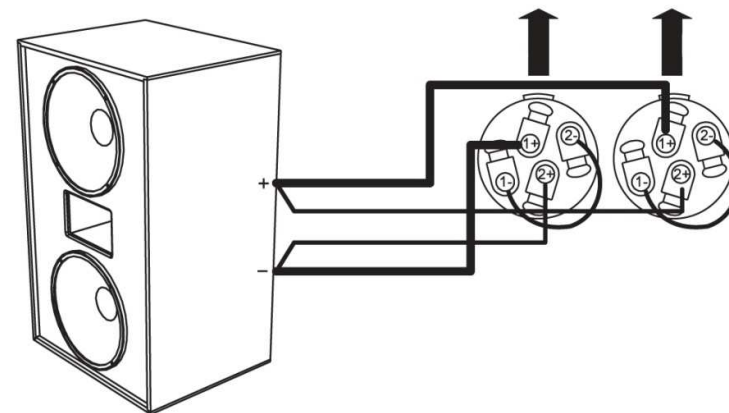

4. Connection

For a given loudspeaker impedance, the proportional power loss as a function of cable length and cable gauge is given in the next table:

| | 8Ω | | | | 4Ω | | | |
|-----------|---------------------|--------------------|-------------------|-------------------|---------------------|--------------------|-------------------|-------------------|
| | 1.5 mm ² | 2.5 m ² | 4 mm ² | 6 mm ² | 1.5 mm ² | 2.5 m ² | 4 mm ² | 6 mm ² |
| 5 meters | 1.4 % | 0.8 % | 0.5 % | 0.4 % | 2.8 % | 1.7 % | 1.1 % | 0.7 % |
| 10 meters | 2.8 % | 1.7 % | 1.1 % | 0.7 % | 5.4 % | 3.3 % | 2.1 % | 1.4 % |
| 15 meters | 4.1 % | 2.5 % | 1.6 % | 1.1 % | 7.8 % | 4.9 % | 3.1 % | 2.1 % |
| 20 meters | 5.4 % | 3.3 % | 2.1 % | 1.4 % | 10.2 % | 6.4 % | 4.1 % | 2.8 % |
| 25 meters | 6.6 % | 4.1 % | 2.6 % | 1.7 % | 12.4 % | 7.8 % | 5.0 % | 3.4 % |
| 30 meters | 7.8 % | 4.9 % | 3.1 % | 2.1 % | 14.5 % | 9.3 % | 6.0 % | 4.1 % |
| 40 meters | 10.2 % | 6.4 % | 4.1 % | 2.8 % | 18.5 % | 12.0 % | 7.8 % | 5.4 % |
| 50 meters | 12.4 % | 7.8 % | 5.0 % | 3.4 % | 22.1 % | 14.5 % | 9.6 % | 6.6 % |

To calculate the SPL losses from these percentages in dB's, the following equation may be used:
 $\text{dB loss} = 20 * \log(1 - (\% \text{loss}/100))$

In the next table a few percentages are converted to dBs:

| % loss | dB loss |
|--------|---------|
| 1 % | 0.1 dB |
| 2 % | 0.2 dB |
| 5 % | 0.4 dB |
| 10 % | 0.9 dB |
| 15 % | 1.4 dB |
| 20 % | 1.9 dB |
| 25 % | 2.5 dB |
| 30 % | 3.1 dB |
| 35 % | 3.7 dB |

The QRP20 has a 4 ohms impedance which makes parallel connection possible of multiple cabinets.

It is technically possible to connect up to 2 QRP20 cabinets on one amp channel, with a resulting impedance of 2 ohms; Typically, we recommend not going any lower in impedance than 2.7 ohms, which means one QRP20; However, in non-high-power applications, the parallel connection down to 2 ohms impedance would not be too much of a compromise.

5. Installation

The QRP20 is to be driven by the ALC controller-amplifier for full system performance, delivering maximum sound quality with increased headroom and utmost operation reliability and flexibility.

The operation reliability is guaranteed by the advanced limiting algorithms in the DSP; The values of the dedicated preset are based on the QRP20 system surviving a 1000 hours durability test in the R&D test bunker at Alcons Audio HQ.

On the ALC, the correct QRP20 preset needs to be selected. Go to the “Preset” tab; tap the button on the channel you wish to operate the QRP20 with; A selection box will appear with the different series groups. (See fig 1) With the encoder select the “Q-series”; then select “QRP20”; (See fig 2) A confirm box will appear. Then select the version you will be using, 90-degree or 120-degree. (See fig 3). Repeat these steps for your 2nd loudspeaker (See fig 4)

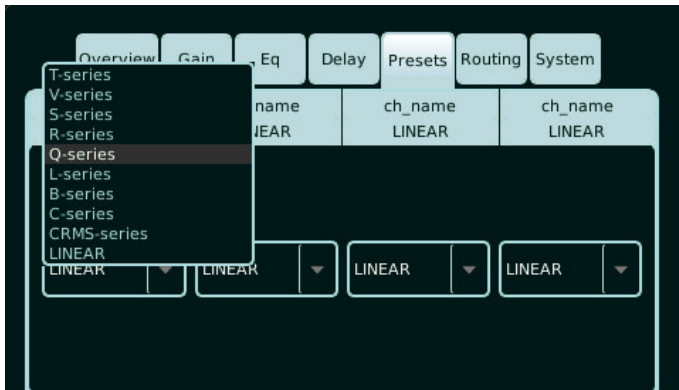

Fig 1. Select loudspeaker 1 > Select Q-series

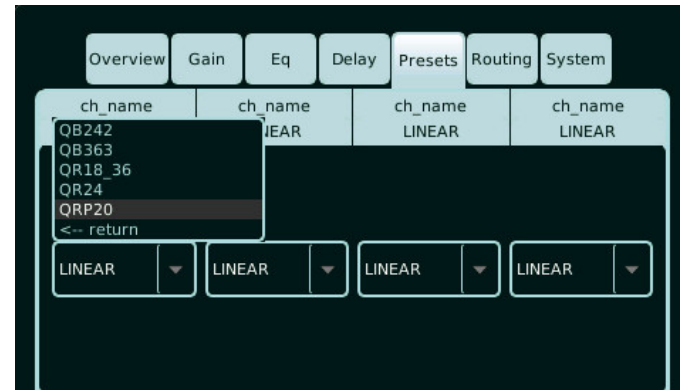

Fig 2. Select loudspeaker 1 > Select QRP20

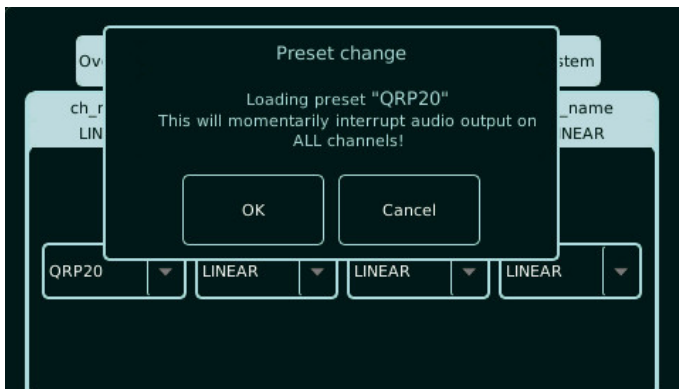

Fig 3. Select loudspeaker 1 > Confirm QRP20, be aware of possible audio interruptions



Fig 4. Select loudspeaker 2 > Repeat the previous three steps for your 2nd loudspeaker

5. Installation

Now the QRP20 is dedicated to this channel; Next you can make a choice of filter settings within the preset: 80Hz high-pass, 100Hz high-pass or full-range operation.

The Alcons VHIR™ processing ensures a flat phase response down to 200Hz with minimal latency; This enables the user to select any Alcons subwoofer to seamlessly work with the QRP20, with optimized phase response.

Optional settings in combination with a subwoofer (QB242 in example): The QRP20 preset can be set on high-pass filtering at 100Hz, depending on the requirement (typically, the 100Hz setting is preferred in higher SPL applications).

To match the QRP20 and obtain a flat system response, the QB242 preset needs to be set on the same frequency preset, 100Hz. (See fig 5)

In applications where the QRP20 is (less ideally) positioned further away from the subwoofer, the QRP20 preset may be set on full-range, with the accompanying sub set on 80Hz. (See fig 6)

Optional settings:

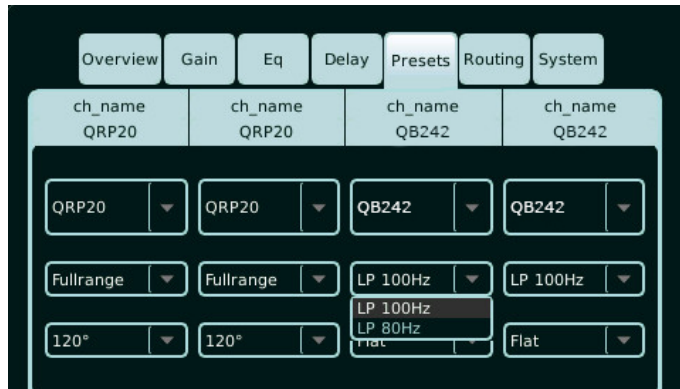

Fig 5. Range selection
Select fullrange or HP at 80Hz or 100 Hz

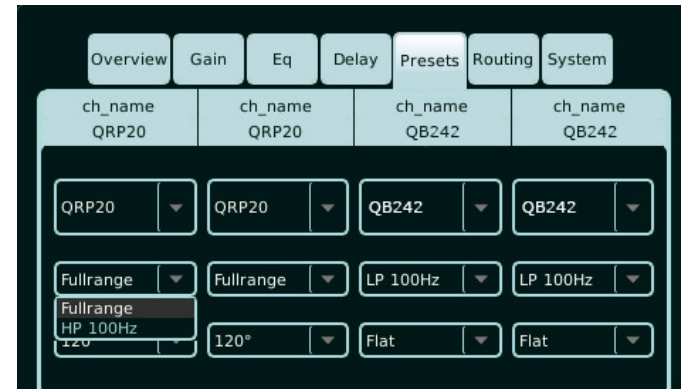

Fig 6. Low-pass filtering
Optional setting for low-pass filtering at 80 Hz or 100 Hz

5. Installation

The dedicated factory QRP20 preset ensures a flat frequency response; With the equalizer and delay sections in the ALC, the performance of the QRP20 can be adjusted to the environment and application. (See fig 7) These settings can be stored in the on-board user-preset bank.

EQ and Delay settings:

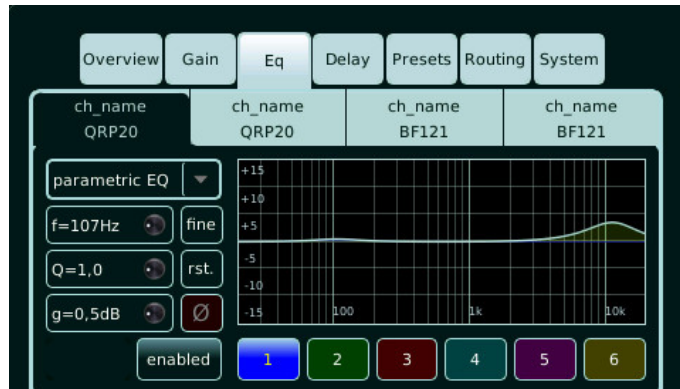

Fig 7. EQ
Frequency adjustment per channel

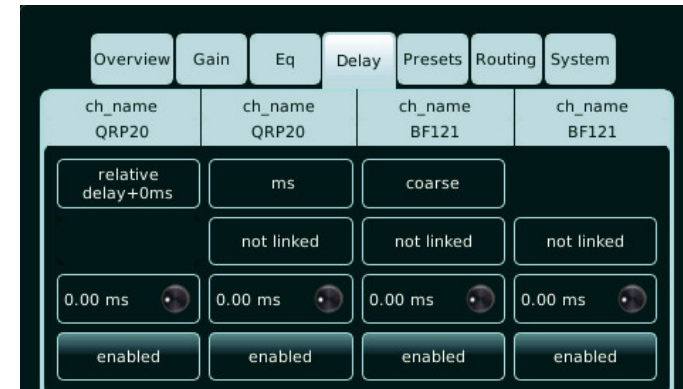

Fig 8. Delay
Delay adjusting to fit the environment

Warning!

Always make sure the correct system preset has been selected, before unmuting / starting-up the system, as operating with incorrect settings can severely damage the loudspeaker and voids warranty.

6. Operation

The QRP20 is equally suitable for mobile deployment as well as fixed installation. Due to the wide 90 or 120 degree x narrow 15 degree HF dispersion, horizontal placement is less critical to still obtain a good audience coverage; However, vertically a correct speaker placement and focus is critical for an optimal performance with minimal spill on floor and ceiling, resulting in an excellent front-to-rear intelligibility.

Constant horizontal directivity = consistent full frequency audience coverage



15° vertical dispersion in reverberant room = audience enjoying clear intelligible sound, even at farther distance

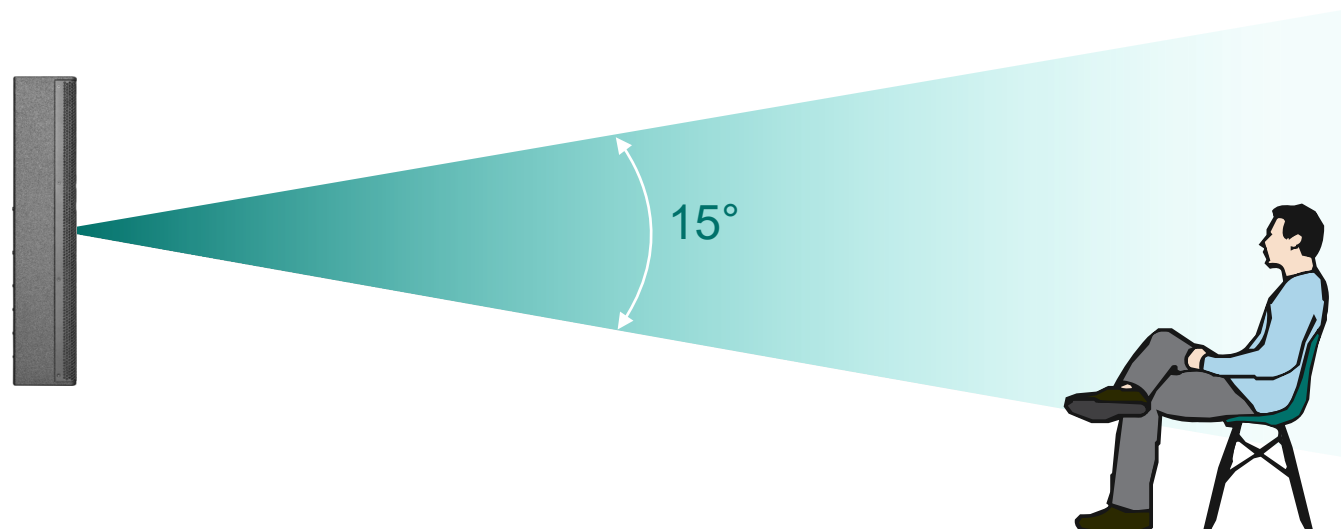

6. Operation

The QRP20's slim cabinet shape makes for a low-profile, unobtrusive mounting. The M10 mounting points on top and bottom and the M6 universal mounting bracket pattern on the back enable the use of swivel brackets, stand mount, shoulder eye bolt and microphone stand deployment to get the best positioning for the QRP20.

Mounting option examples:

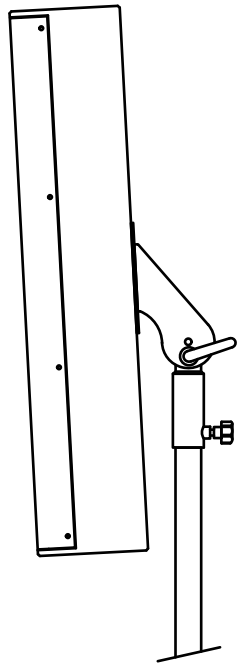

Standmount w. pan/tilt
10° down and 60° up
(STMTADAP)

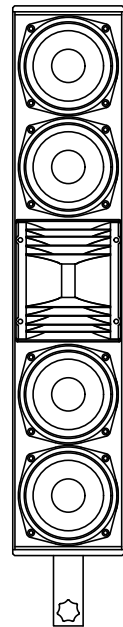

Standmount non pan/tilt
reducer flange 36mm to
M10 thread (STMTM10)

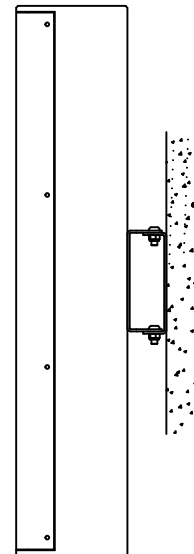

Wall mount w. pan
35° left/right panning.
Allows narrow wall mounting
6cm / 2.36 in. depth (WMT1)

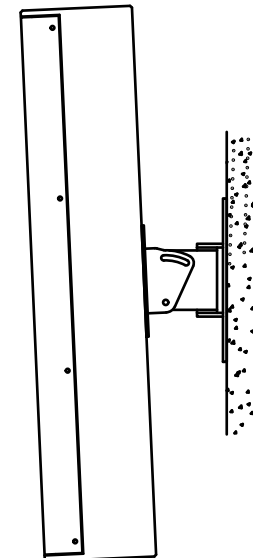

Rear-mount w. pan/tilt
(K&M 24471 + 24356
(AP3))

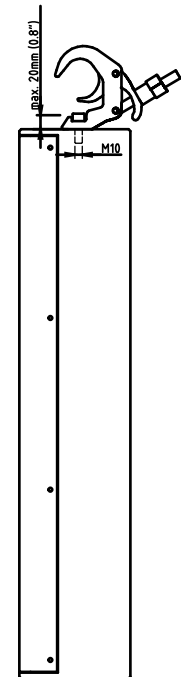

Truss clamp
M10 w. thread length max.
20mm (0.8") below clamp

7. Accessories & options

Mounting options:



BRKQRP20

The BRKQRP20 is a swivel yoke for a single QRP20. The yoke is connected to the cabinet with four M6 bolts on the rear of the cabinet. The bracket can be fitted with an optional truss clamp, TV-spigot or STMT stand-mount adapter, with M10 (2) or M12 (1) bolt/nut connection.

The BRKQRP20 is certified for a safety-rating of 10:1, for one cabinet QRP20 and has a weight of 3 kg / 6.6 lb.



WMT1

The WMT1 is a bracket for mounting one QRP20 to a wall or column. It is designed for “pan-only” application, requiring a minimum of mounting depth. WMT1 enables a 35° left and right panning, with only 6cm / 2.36 in. cabinet-to-wall depth. It is connected to the cabinet with four (4) M6 bolts in a standard pattern.

7. Accessories & options

Mounting options:



STMTADAP

The STMTADAP is a 36mm stand mount sleeve, enabling speakers to be used on standard tripod stands or mounting accessories with a diameter of 35mm. It can be mounted on the rear of the cabinet through the accompanying adapting mounting plate, with two (2) M6 thread connection and M6/M8 universal mounting pattern. Includes a small diameter grip knob.

This adjustable stand sleeve enables pan and tilt with 10° down and 60° up.



STMTM10F

The STMTM10F is a 36mm stand mount sleeve, enabling speakers to be used on standard tripod stands or mounting accessories with a diameter of 35mm.

It can be directly mounted on the cabinet, with the M10 thread connection. Includes a small diameter grip knob. The flange provides extended stability in applications with tall speakers, like QRP20 or QRP40.

7. Accessories & options

ACO™ Colour option:



ACO™ (Architect Colour Option)
The QRP20 can be finished in any of the 180+ colours from the European RAL™ colour scheme

Transport options:



FC2QRP20
Flightcase for 2 pcs. QRP20 + 2 pcs. STMTM10 reducer flange

8. Specifications

QRP20 product views

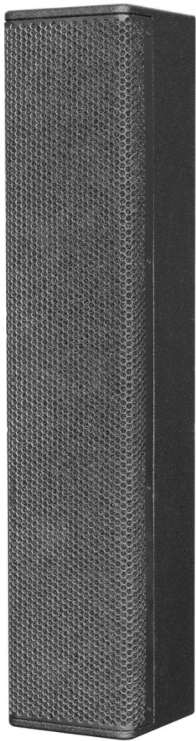

QRP20 - Front



QRP20 - Side

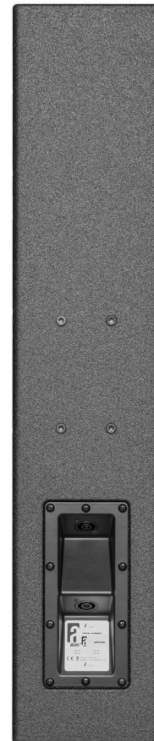

QRP20 - Rear

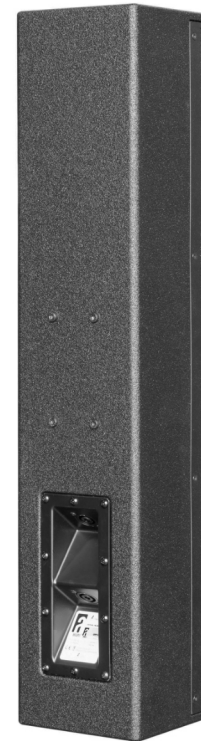

QRP20 - Rear/side

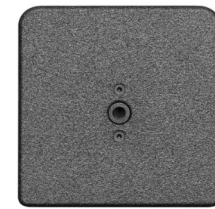

QRP20 - Top / bottom

8. Specifications

| Technical specifications | |
|---------------------------------|-------------------------------------|
| Frequency response | 72 Hz - 20.000 Hz (+/- 3 dB) |
| | 64 Hz - (+/- 10 dB) |
| Sensitivity nominal - QRP20/90 | 99 dB (200 Hz - 10 kHz) |
| Sensitivity nominal - QRP20/120 | 97 dB (200 Hz - 10 kHz) |
| Nominal impedance | 4 ohms |
| Recommended drive | Sentinel3 min. |
| Nominal SPL peak - QRP20/90 | 128 dB (Sentinel3 200 Hz - 10 kHz) |
| | 133 dB (Sentinel10 200 Hz - 10 kHz) |
| Nominal SPL peak - QRP20/120 | 126 dB (Sentinel3 200 Hz - 10 kHz) |
| | 131 dB (Sentinel10 200 Hz - 10 kHz) |
| Dispersion H x V | 90° x 15° or 120° x 15° (@ 20 kHz) |

| Physical specifications | | |
|-------------------------|--------------------------------|---------|
| System | 2-way, full-range | |
| Filtering | passive | |
| Driver LF | 4x AMB5NDAIC-16 5", sealed | |
| Driver HF | 1x RBN401 4" pro-ribbon driver | |
| Connectors | 2x Speakon NL4 input/link | |
| Physical dimensions | mm | inches |
| Height | 742 | 29.2 |
| Width | 150 | 5.9 |
| Depth | 150 | 5.9 |
| Weight (approx.) | 12 kg | 26.5 lb |
| Warranty | 6 years limited | |

8. Specifications

Dimensional drawing

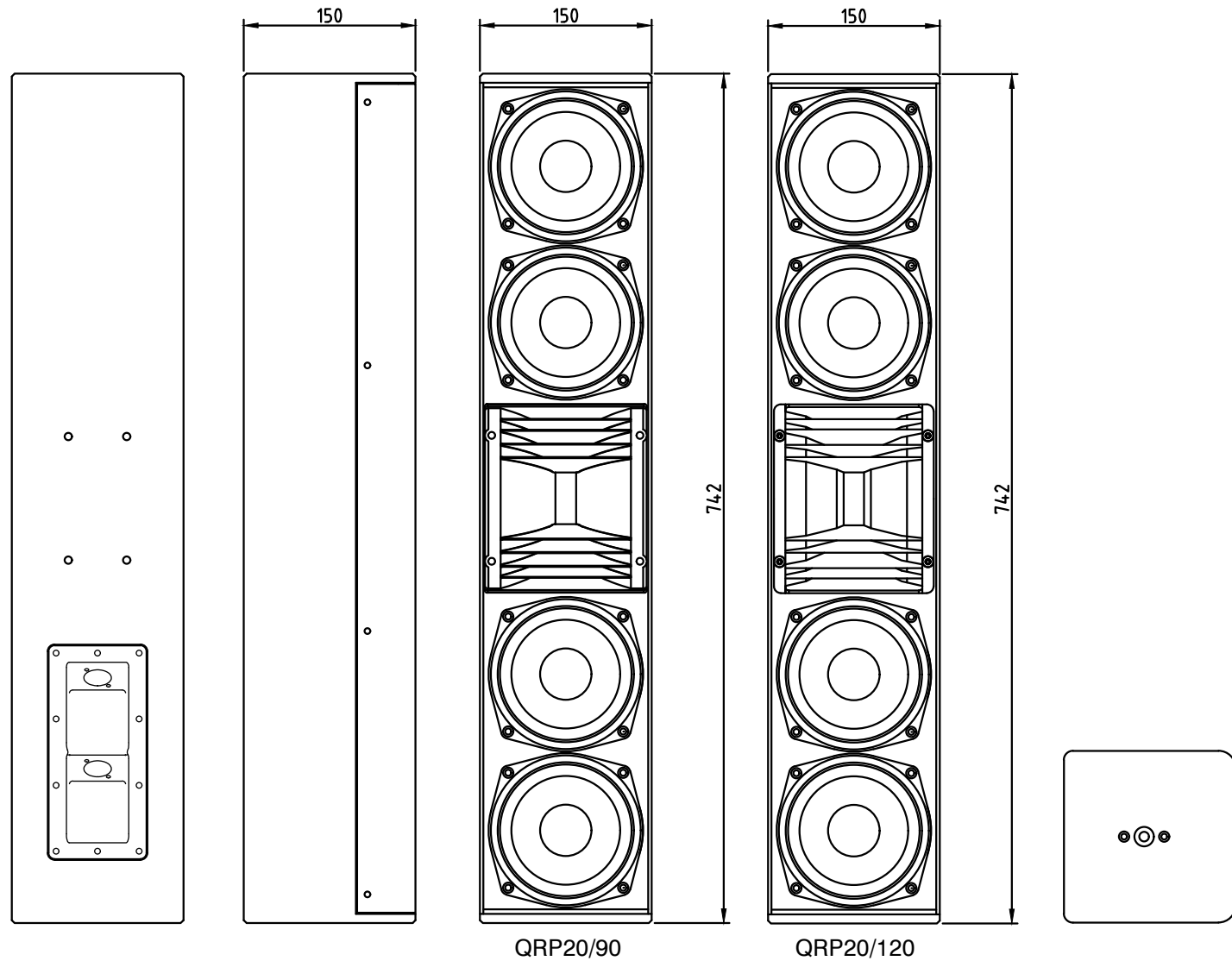

Drawing not to scale



9. Simulation

The projection performance of the QRP20/90 can be simulated through the EASE programs. Visit www.alconsaudio.com/simulation to download the GLL data set.

QRP20/90 Horizontal:

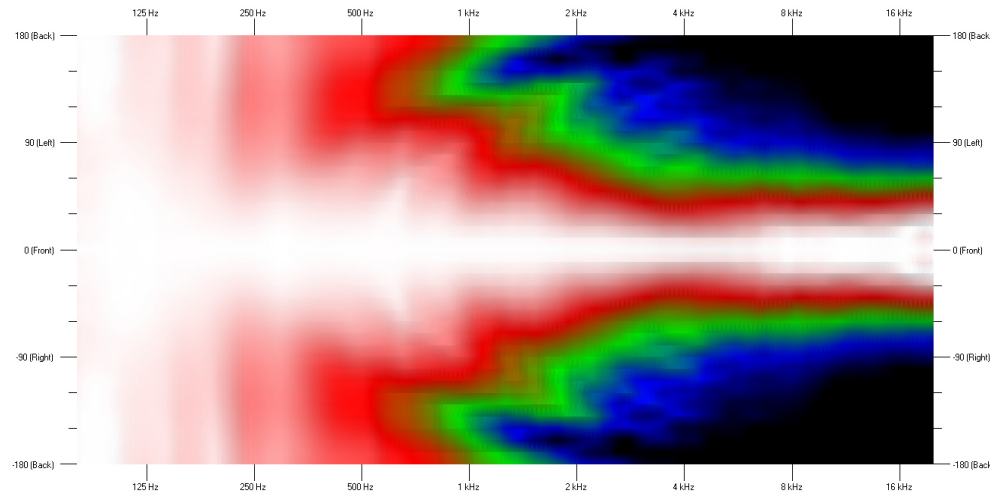

QRP20/90 Vertical:

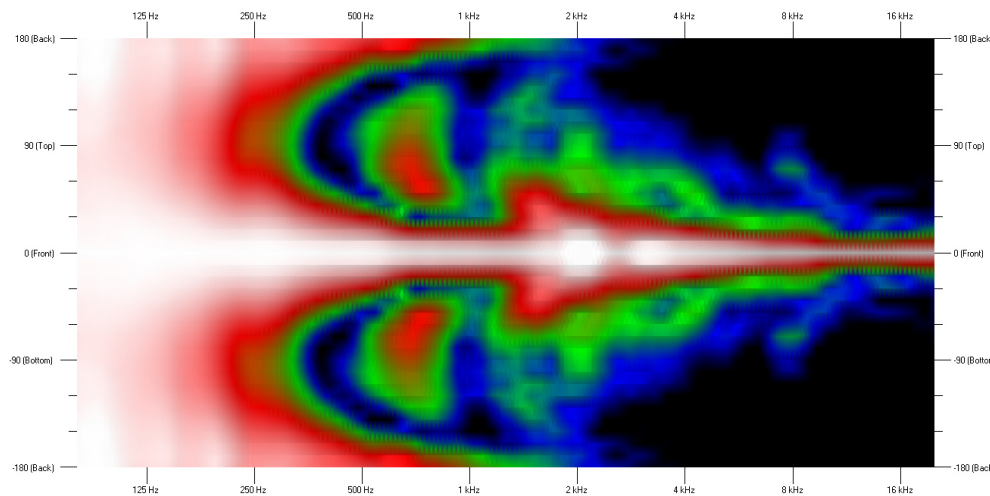

9. Simulation

The projection performance of the QRP20/120 can be simulated through the EASE programs. Visit www.alconsaudio.com/simulation to download the GLL data set.

QRP20/120 Horizontal:

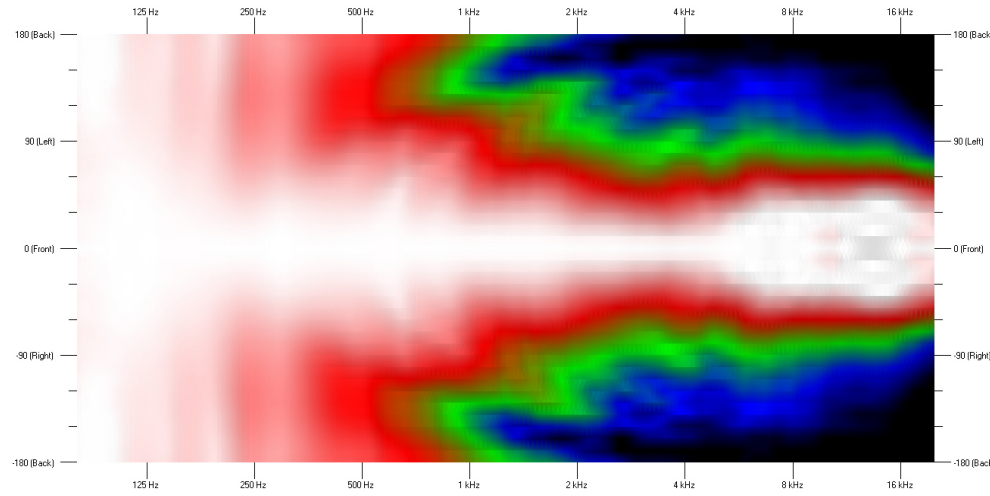

QRP20/120 Vertical:

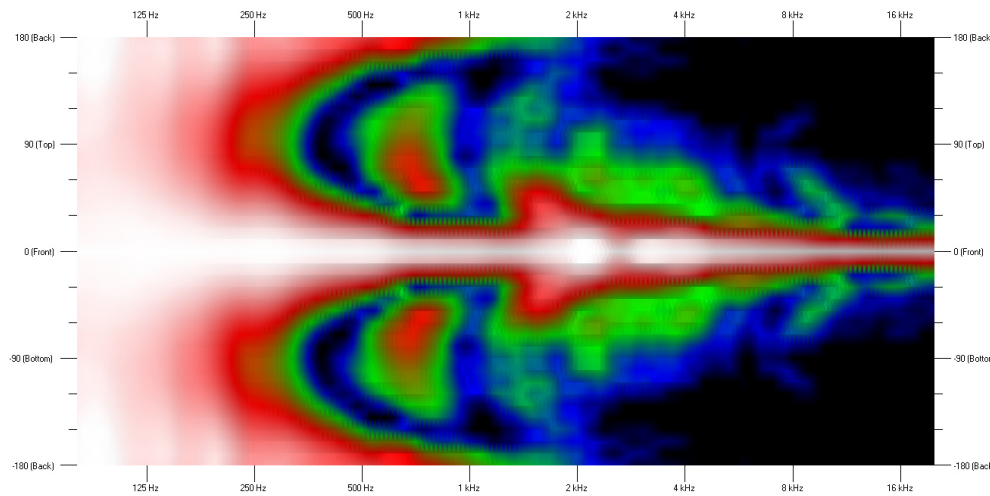

9. Simulation

The projection performance of the QRP20 can be simulated through the EASE programs. Visit www.alconsaudio.com/simulation to download the GLL data set.

Frequency & phase response

Data Shown: QRP20 (Alcons Audio)
Display Parameters: Frequency: 1000Hz (1/3rd Octave) Mer: 0° Par: 0°

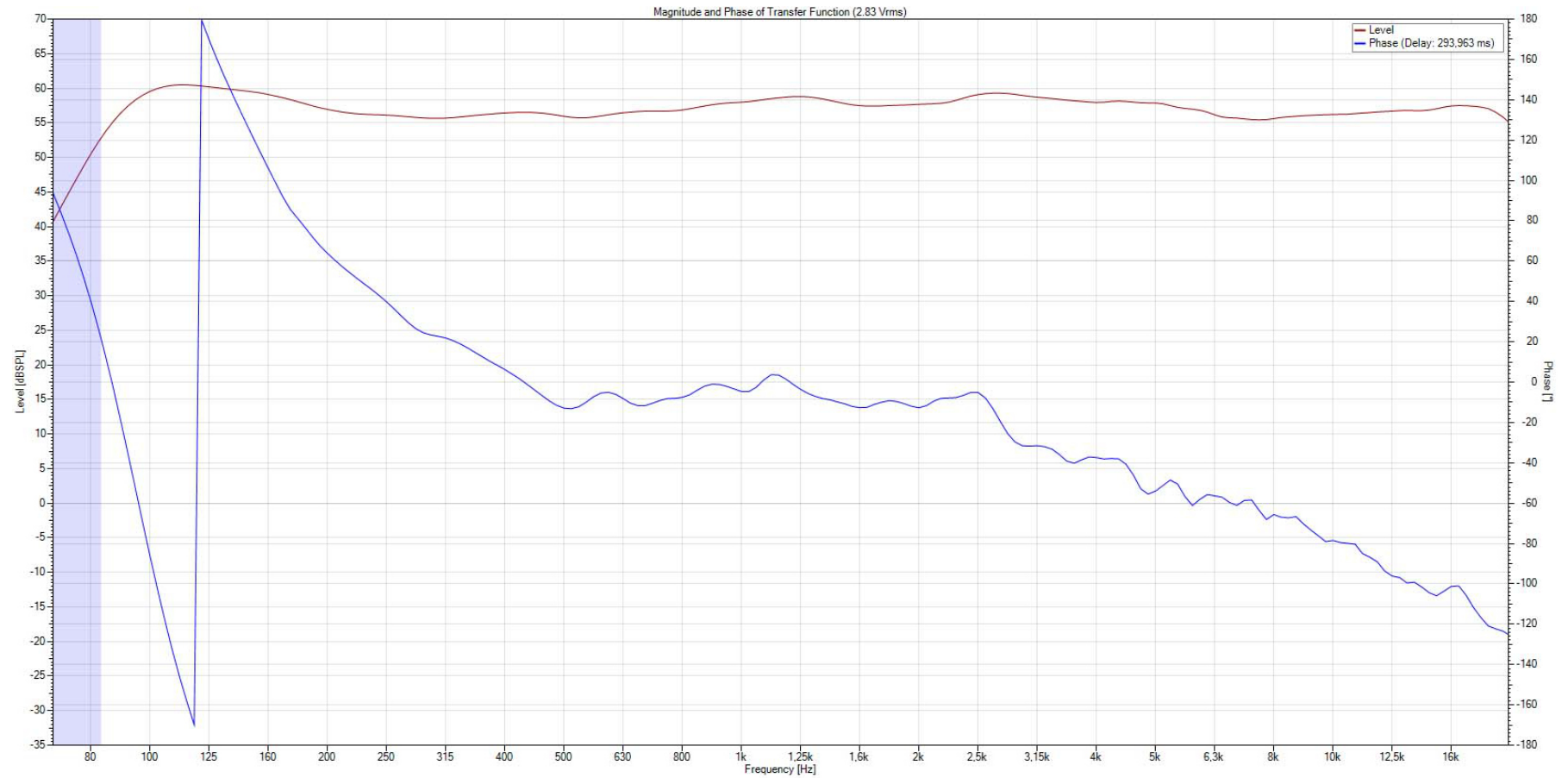

10: Service and support

Warranty

Summary

Alcons Audio BV warrants the original purchaser and any subsequent owner of each new Alcons product, for a period of six years limited from the date of the original purchase by the original purchaser, that the new Alcons product is free of defects in materials and workmanship. Alcons Audio BV warrants the new Alcons product regardless of the reason for failure, except as excluded in this warranty, you must keep the original sales receipt to establish the exact date of purchase.

Item excluded from warranty

Warranty does not cover any product which has been damaged because of any misuse, accident, or negligence. Warranty also does not extend to a new Alcons product if the serial number has been defaced, altered or removed.

What we will do

Alcons Audio BV will replace defective parts and repair malfunctioning products, regardless of the reason for failure (except as excluded). Warranty work can only be performed at our authorized service centres, or at our factory.

Disclaimer

Alcons Audio BV is not liable for any damage to loudspeakers, amplifiers, or any other equipment that is caused by negligence, misuse or improper installation. Alcons Audio is not liable for any incidental damages resulting from any defect in the new Alcons product. This includes any damage to another product or products resulting from such a defect.

Alcons Audio BV reserves the right to change specifications without notice.

10: EC declaration of conformity

Alcons Audio BV
De Corantijn 10
1689 AP ZWAAG
The Netherlands

States that the following products:

QRP20/90
QRP20/120

Are in conformity with the provisions of:

Low Voltage Directive, 2006/95/EC
Electro-Magnetic Compatibility Directive, 2004/108/EC

Applied rules and standards:

EN60065 (Electrical Safety)
EN55103-1 (Emission)
EN55103-2 (Immunity)

Established at Zwaag, the Netherlands,
November 1st, 2022

T.H. Back
Managing Director





A: Alcons Audio HQ
De Corantijn 10
1689 AP, Zwaag
The Netherlands

T: + 31 (0) 229 28 30 90
E: info@alconsaudio.com

A: Alcons Audio USA
PO Box 1410
Felton, CA 95018
United States of America

T: +1 (949) 439-8203
E: info@alconsaudio.us

A: Alcons Audio GmbH
Stargarderstraße 2
30900 Wedemark
Germany

T: +49 (0) 5130 586811
E: info@alconsaudio.de

evolutionary audio solutions™
alconsaudio.com